

24



WITTENSTEIN

A day with us is never ordinary,

because WITTENSTEIN is an extraordinary company in many ways. A pacesetter in mechatronic drive technology and an international group. We are also an independent family firm from the Tauber Valley in Baden-Württemberg with a clear philosophy and values that are reflected in everything we do.

Innovation is our passion: forging new paths and breaking new ground – that is what drives us from day to day. Time and time again, our knowledge and our capabilities help our customers secure key competitive advantages.

24 hours

This brochure is designed to provide you with a few insights into the way we work. Discover what moves the things we set in motion for our customers – and what moves us – on a 24-hour trip through our world.



48 Further Training



46 Nanoprecision



44 Vocational Training



42 World Garden



40 Innovation



38 Pioneers hit the Road



36 Digitalization



8 History



10 Service



12 Sustainability



14 Quality



16 Commitment



18 Pioneering Achievements

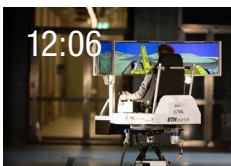

20 Networks

23 What we can do for you



WITTENSTEIN's path
on the way to becoming an
international group of companies
began with women's gloves.
In 1949, the two entrepreneurs
Bruno Dähn and Walter Wittenstein
founded DEWITTA as a manufacturer
of glove sewing machines.



History

With fewer and fewer women wearing gloves in the seventies, the company founders decided to expand into new markets and shifted the emphasis to technical products. Manfred Wittenstein, Walter Wittenstein's son, joined the business in 1979. Not long after, he and his team developed the first low-backlash planetary gearboxes and revolutionized the production and product portfolio.

Today, WITTENSTEIN is a driver of innovation in mechatronic drive technology. We develop customized products, systems and solutions for highly dynamic motion, maximum-precise positioning and smart networking. Our passion for innovation motivates us to continuously optimize key technologies for electromechanical drive systems and explore new application worlds. Our developments invariably have a supporting function in that they are designed to serve people – our inventions must make a meaningful contribution towards meeting socially relevant needs and challenges.



DEWITTA glove sewing machines have a reputation for excellent quality. They are still used by many companies in production today.

03:12

Yimin Ding works for us as a service technician in Hangzhou, China.

He nearly always travels to his assignments by train – the special adhesives he needs to do his job are not allowed to be taken on a plane. His journey time from our subsidiary on the East China Sea coast to the Xinjiang district in the far west of the People's Republic, for example, is more than 52 hours.

He crosses four climate zones in the process.





Service

We want to set new standards with our holistic service concept. Through our close partnerships, we frequently offer our customers guidance over many years. We give sound recommendations and determine jointly which service is appropriate and at what time. Among other things, this allows you to plan investments or maintenance well in advance. And if things have to move really fast, our service hotline is there to advise you immediately. For many defined products, our service staff can be reached directly 365 days a year. We also take the fast lane when shipping new products: by choosing our speedline® service, you can profit from delivery within 24 or 48 hours for certain items.

Service and maintenance are top priorities for us. However, in the past, no recognized profession existed that reflected the interdisciplinary profile comprised of technical qualifications, service orientation and management methodology. That's why we initiated a new professional qualification and were heavily involved in developing it – with considerable success: the newly established dual study program in Service Engineering at Baden-Württemberg Cooperative State University in Mannheim is extremely popular with students.

A current customer survey confirms that our idea of service meets with widespread approval. We perform one whole school grade better compared to the VDMA average.

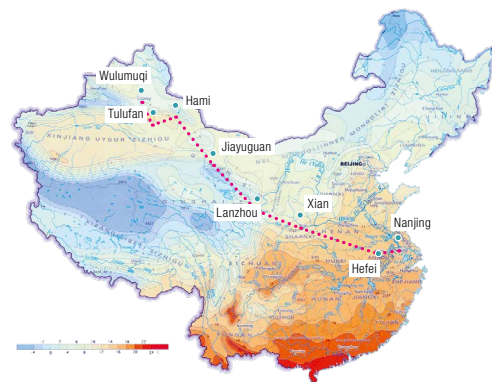

It's not at all unusual for Yimin Ding to install racks one week at temperatures as low as -15°C and provide training a few days later in a +40°C heatwave.

06:29

Motorcycle riders can experience a complete new way of driving: 0% noise, 0% emission but 100% fun to drive.

The C evolution by BMW Motorrad is the first fully electric maxi scooter in the high-end segment.

When developing this cutting-edge vehicle, BMW Motorrad chose WITTENSTEIN as its technology and innovation partner.

The inverter, electric motor and parts of the gearbox for the BMW C evolution were developed by us.

With our ideas for tomorrow's powertrain, we enable more sustainability in the transport sector.





Sustainability

For us, sustainable management is a long-term factor for success and a driver of innovation. Our aim is to combine optimal product quality with the sparing use of resources.

Under our SIR market strategy – Security, Intelligence and Resource Efficiency – we have already been monitoring sustainability for a long time. In other words, our components and systems must either be resource-efficient themselves or contribute to boosting the resource efficiency of the overall system (such as the machine in which they are installed). Our production processes are likewise as energy efficient and environmentally friendly as possible.

Many of our projects are currently driving digital networking. For instance, by continuously exchanging information, we ensure that maintenance of our systems can be planned well in advance. We can also have the ability to analyze performance and provide recommendations for optimizing it. All of this saves considerable capital, material and energy.

When planning new buildings, too, or modernizing existing ones, we pay attention to sustainability. At our Urban Production facility in Fellbach, for example, we are saving 35% on energy costs compared to the old plant – with fully air conditioned production.



The Innovation Factory in Igersheim-Harthausen and the Urban Production site in Fellbach are breaking new ground in terms of energy and resource consumption. Our efforts have been rewarded with a certificate in platinum testifying to the compliance by both buildings with the stringent requirements of the DGNB (German Sustainable Building Council).



07:34

The WITTENSTEIN winding shop is part of our Innovation Factory. Olga Schröder is a familiar face here. She always works very precisely, which is why she is our specialist for distributed, twist-free winding. This type of winding is only possible by hand but results in motors of the very highest quality. Right now, Olga Schröder is making a specialized medtech product.

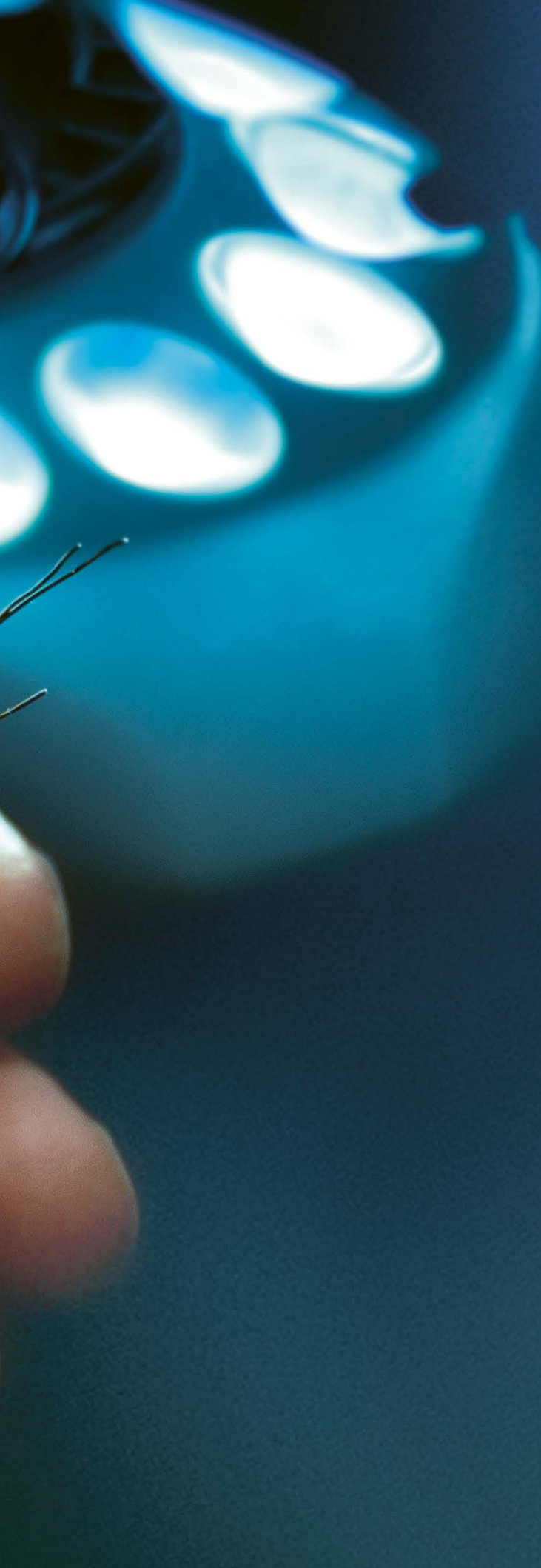

Quality

At WITTENSTEIN, quality comes first. It's at the forefront of our minds from the product creation process onward: all new products are designed to be as robust as possible. Using risk analysis methods such as FMEA (Failure Mode and Effects Analysis), we detect weaknesses at an early stage and introduce countermeasures to reduce them. The outcomes are then verified and validated during the trial phase. Only if a product passes all of these tests without exception is it transferred to serial production.

Suitable quality assurance concepts are in place for our products throughout the supply chain – from the supplier through incoming goods as well as production and assembly to shipping. With our sights firmly set on our goal of zero defects under serial production conditions. Our customers show great appreciation for our excellent product quality. This is also reflected in our very low warranty and goodwill costs. At 0.19%, these were significantly lower than the industry average of 1.4% in 2017 (source: VDMA).

The quality of our processes, too, plays an important role alongside product quality. All processes are described in our management system. All our employees know exactly what needs to be done and when. Competencies and responsibilities are clearly defined.



Our aim is to offer our customers the highest quality, no matter where they happen to be in the world. That's why our actions are based on uniform standards and rules as laid down in ISO 9001, for example. All WITTENSTEIN facilities worldwide are certified according to the latest version.

09:53

Marvin Post and his team have every reason to be proud. They've just built a brand new chicken coop for the Protestant retirement home in Bad Mergentheim.

And it isn't just the chickens that are reaping the benefits: WITTENSTEIN's new trainees and students got to know each other really well while collaborating on this unusual project.



WITTENSTEIN



Commitment

All trainees and students begin their WITTENSTEIN adventure with a “Come Together Week”. A series of group activities are designed to strengthen the “we” feeling and communicate the values of our corporate philosophy – responsibility, trust, openness, innovation and change – in an unconventional way.

Something we call “Aktiv vor Ort” (Active on the spot) is traditionally one of the highlights of the week. WITTENSTEIN employees submit suggestions for social projects where the new trainees and students will have a chance to demonstrate their commitment. They renovate playgrounds, for example, build barefoot paths or modernize barbecue areas. This all adds up to nearly 1000 hours of community service work every year for nonprofit organizations.

Our commitment to the local region also extends to numerous other activities such as DEBUT, the Classical Singing Competition, a scholarship for outstanding school leavers, our “Creative Young Minds” competition for budding inventors or the WITTENSTEIN Art Exhibitions, at which artists from the Tauberfranken area have a chance to show their works.



The DEBUT Classical Singing Competition supports opera singers embarking on their career. It is held every second year in the Tauber Valley. The competition was initiated by Dr. Manfred Wittenstein.



11:27

Thanks to our revolutionary Galaxie®, our customer NIMAK was able to break with all previous design conventions and completely reinvent the welding gun. The decisive innovation was as follows: our highly dynamic drive system is integrated into such a small space that it can be mounted directly at the gun's pivot point. That, in turn, allows much more rapid opening and closing of the gun arms; the force generation time is shorter and the repeat accuracy of the electrode force extremely high.





Pioneering Achievements

Again and again, our Galaxie® causes existing design strategies in high performance engineering to be completely overturned. This is because the new gearbox class is superior on principle. It is based on three radically new ideas: dynamic teeth instead of a rigid gear ring, hydro-dynamic tooth contact over the full surface when loaded rather than pitch-point linear contact and teeth in the form of a logarithmic spiral.

As a result of these innovations, our compact Galaxie® Drive Systems and hollow-shaft gearboxes deliver next-generation performance. Extreme torque density, torsional rigidity, synchronization and positioning accuracy and absolute freedom from backlash are just a few examples. Our invention was honored with the HERMES AWARD 2015 and the Innovation Award of the German Economy 2016, and it was also nominated for the Deutscher Zukunftspreis 2018.

Behind our inventions lies a mentality which we have been practicing consistently for decades: we encourage our employees to adopt an unconventional approach to the challenges awaiting them. Nonconformist thinking is expressly welcomed at WITTENSTEIN. It is our profound conviction that this mentality is the fertile ground on which great ideas can thrive.

Against this background, it comes as no surprise to learn that we have a long tradition of pioneering achievements. Back in 1983, we unveiled the world's first low-backlash planetary gearbox at the Hannover Messe.



Galaxie® is now also featured in an academic textbook:
"Werkzeugmaschinen Fertigungssysteme 3"
(Machine tools and manufacturing systems 3),
edited by Professors Christian Brecher and Manfred Weck,
describes it as a new, independent gearbox class.

12:06

Freeing people trapped under collapsed buildings, stabilizing steep, landslide-prone slopes, rescue operations following an avalanche, clearing landmines, work in zones affected by radioactivity: these are just a few of the possible scenarios in which the teleoperated ibex excavator can be used. Students at ETH Zurich developed a telecontrol platform for this vehicle. They were supported by our Swiss subsidiary in Grüşch.





Networks

Our willingness to engage in dialog is not simply evident in our cooperation with universities – like the Technical Universities of Munich and Dresden, RWTH Aachen University or the Bad Mergentheim Campus of Baden-Württemberg Cooperative State University Mosbach. A constant, intensive exchange also takes place with our customers, the public at large, scientists and politicians. Only companies which are optimally networked in all directions can succeed in identifying needs in good time and deriving appropriate solutions.

For example, we maintain close ties with the VDMA (German Engineering Federation), of which Dr. Manfred Wittenstein was President from 2007 to 2010. We are also involved in the various think tanks of the FVA (German Research Association for Power Transmission). Parallel to this, we have established intensive international contacts, among others with the GACC (German American Chamber of Commerce of the Midwest) in Chicago.



ETH Zurich is a university for science and technology in Switzerland's biggest city. It is one of the top ten universities in the world and is widely regarded as number one in continental Europe. It was founded in 1855 as the Federal Polytechnical School.

What we can do for you





WITTENSTEIN helps you secure key competitive advantages

We develop, produce and sell customized products, systems and solutions for highly dynamic motion, maximum-precise positioning and smart networking for mechatronic drive technology. Our aim is to provide innovative and future-proof solutions that help you stay at the cutting edge. We have Strategic Business Division for this purpose with specific core competencies united under one roof.

You can find our products in industry, in people, in space and underground. Our portfolio includes low-backlash planetary gearboxes, complete electro-mechanical drive systems and AC servo systems and motors. They are used, among other things, in robotics, machine tools, medical technology and aerospace.

Our fields of competence

Machine & Plant Construction



For decades, we have served as a competent partner to companies involved in the development, design and manufacture of machines for factory and process automation. During this time we have built up unrivaled know-how in a variety of industries. Our customers profit from our outstanding expertise in the following fields:

Automation, Robotics, Handling



We offer gearhead and actuator solutions as well as small servo motors for the rotary axis. These solutions are suited for use in all manner of environments: versions for dry areas and applications where strict hygienic and chemical resistance requirements apply. A broad array of precise and highly dynamic motors are available for those applications where a high throughput is called for. iTAS® – our modular servo drive system – sets benchmarks in the intralogistics sector. Every one of our solutions is characterized by absolute compatibility as well as maximum flexibility and scalability.

Semiconductors & Electronics Assembly

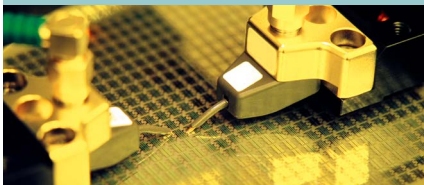

In the semiconductor industry the highest possible precision is a vital prerequisite. Reliability and productivity are other crucially important aspects. The drives must be designed as compact as possible owing to the mounting situation. We offer solutions combining extreme power density, high dynamics and precision. Our drives provide optimal synchronous running – even in vacuum environments, leading to significantly higher throughputs.

Woodworking



A combination of dynamics, precision, efficiency and process reliability is called for in the woodworking industry. We supply gearboxes, actuators and mechanical linear systems to meet all needs: our portfolio includes precise and highly dynamic drive systems for complex applications with high requirements. At the other end of the spectrum, our Basic and Value planetary gearboxes and linear systems unite high quality and precision with extremely attractive prices.

Plastics & Rubber Processing



Dynamic drives are a good strategy for raising productivity. The use of linear actuators for high forces is another possible option. The systematic selection of servo technology rather than hydraulics is recommended in many cases as a way to improve energy efficiency. The power dense drives we offer for this purpose are perfect for plastics processing machines, where space is generally restricted.

Food & Packaging



We provide a comprehensive portfolio of drive solutions all along the production line – from manufacturing to packaging of the foods in wet or dry areas. Our highly specific gearboxes, servo actuators and motors feature an EHEDG-compliant design with protection ratings up to IP69K. Our Hygienic Design gearbox is the first planetary gearbox in the world to earn EHEDG certification. Our cymex® 5 sizing tool ensures optimal integration of the drive technology in the machine's overall system.

Machine Tools



Our products are characterized by high precision, excellent performance and power density and exemplary reliability. That helps reduce manufacturing costs and enhance the efficiency of the machines. Low-backlash planetary gearboxes, mechanical and mechatronic linear systems, actuators and highly precise, customized servo motors are an integral part of our portfolio. Our revolutionary Galaxie® Drive System achieves torque and stiffness characteristics several times better than traditional hollow-shaft drives.

Other Industries



Cutting-edge technology made by WITTENSTEIN is also found in numerous other industries such as glass engineering, textile processing, printing & paper or special-purpose machines for an array of uses. Our portfolio includes low-backlash planetary gearboxes, high-precision spur and bevel gear sets, gearing components for driven tools, linear systems, actuators and complete mechatronic drive systems.

Aerospace



It is a priority for the aviation industry to develop ever more efficient aircraft without compromising on safety. Thanks to their excellent power-to-weight ratio and reliability, our mechatronic systems contribute towards achieving and exceeding this objective. Our EASA approval and global service network enables us to offer all essential services to provide system suppliers, aircraft manufacturers and airlines with reliable mechatronic drive capacity for the entire life cycle of an aircraft.

Automotive & E-Mobility



Since 2006, we have set benchmarks worldwide for power density, efficiency and intelligence for the drive trains of electric and hybrid vehicles. Our catalog includes traction drives, generators and electric drives for turbochargers and compressors, including smart control software. Our unique engineering solutions and serial products are especially used in space-restricted applications or for small serial quantities.

Energy



We have long been working successfully on solutions for energy efficient drives, new generations of power generators and energy recovery systems for many sectors. Thanks to their extremely high resistance to radioactivity, our radiation-proof rotary servo motors, actuators and generators open up completely new applications for nuclear power plant operators. On request, we build products in strict compliance with IEEE standards or explosion-proof to ATEX guidelines.

Medical Technology



In the medical technology sector, where mechatronic drive solutions play a major role, we are an experienced and innovative partner. For more than 20 years now, we have been developing and producing motors for various cardiac assist systems. These motors are wear-free as well as extremely lightweight and compact. They have meanwhile been used in well over 1000 patients.

Measuring & Testing Technology

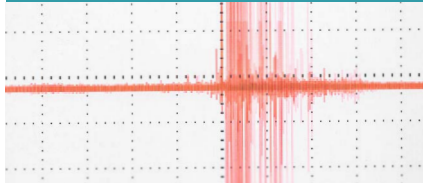

Modern production processes are increasingly complex. To control them accurately and reliably, the measuring and testing technology must be taken to new levels of precision and compactness. Our IDS3010 sensor enables dynamic, nanoprecise measurements in industrial applications for the first time. Our ultra-compact, customized drives simultaneously open up new possibilities for developing systems and equipment – even in extreme environmental conditions.

Nanotechnology

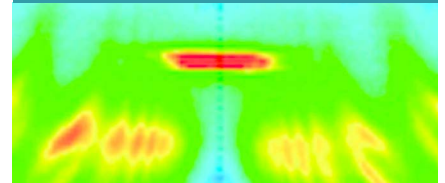

In order to record, research and further develop the nanotech world, you need instruments that work reliably even in the subatomic range. For over 10 years now, we have been developing and producing nanoprecise sensor, actuator and microscopy solutions that push the limits of what is physically and technically possible. This work is interdisciplinary and innovative: we are ready to forge new and highly innovative paths with our customers.

Oil & Gas Exploration



The ambient conditions in the oil and gas industry place stringent demands on machines and systems. Our rotary servo motors and generators are available either with or without a housing; they are highly shock and vibration-resistant and enable stator winding temperatures up to 240°C and ambient pressures up to 2100 bar. To allow oil and gas to be processed and extracted on land or below the ocean surface, we offer highly integrated mechatronic systems with extremely robust designs and high-precision calibrations.

Simulation



Flight simulators enhance air safety. They can be used to provide civilian and military pilots with practical instruction and training. Control loading systems are the sensitive human-machine interfaces in such simulators. We offer our customers these systems from a single source, including all the integrated hardware and peripherals as well as the necessary software systems and programming for aircraft type-specific databases.

Digitalization



Digitalization is a chance to make growing complexity and the increasing trend towards mass customization manageable. This can only happen within a digitally networked manufacturing environment. That is why we develop a broad range of products and solutions for environments in which production machinery and logistics systems are linked together and will have the capability to organize themselves in the future. We also offer our customers digital services which support condition monitoring or predictive maintenance, for instance, as well as attractive online tools that provide valuable assistance from a product finder to after-sales.

WITTENSTEIN alpha



WITTENSTEIN alpha develops, produces and sells mechanical and mechatronic servo drive systems for application-specific needs. Our products consistently raise the bar around the world.

We have divided our product portfolio into four segments in order to meet very different requirements: in the Premium and Advanced segments, we focus on technology and performance while in the Value and Basic segments, the emphasis is on cost-effective and high-demand products.

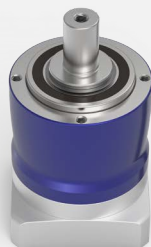
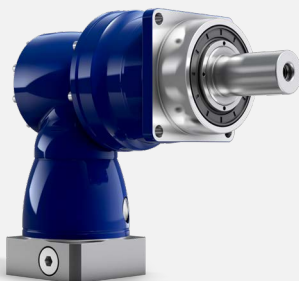
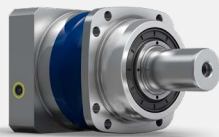

WITTENSTEIN cyber motor



cyber motor

WITTENSTEIN cyber motor develops, produces and sells technologically advanced servo motors and demanding drive electronics as well as complete mechatronic drive systems with maximum power density. Our expertise is in specialized motors for ultra-high vacuums, high temperatures and radioactive environments.

We collaborate closely with our users on individual projects to exchange ideas, learn from each other and discover new opportunities that help our customers stand out from the competition.



WITTENSTEIN galaxie



galaxie

WITTENSTEIN galaxie develops, produces and sells radically innovative gearboxes and drive systems based on a totally new functional design principle. With this unique expertise, we are the global leader in rotary mechatronic drive technologies.

These innovations help our customers designing machinery with vast performance parameters to secure their competitive core-advantages for the future. Our solutions enable products to be manufactured in a particularly efficient and resourceful way.

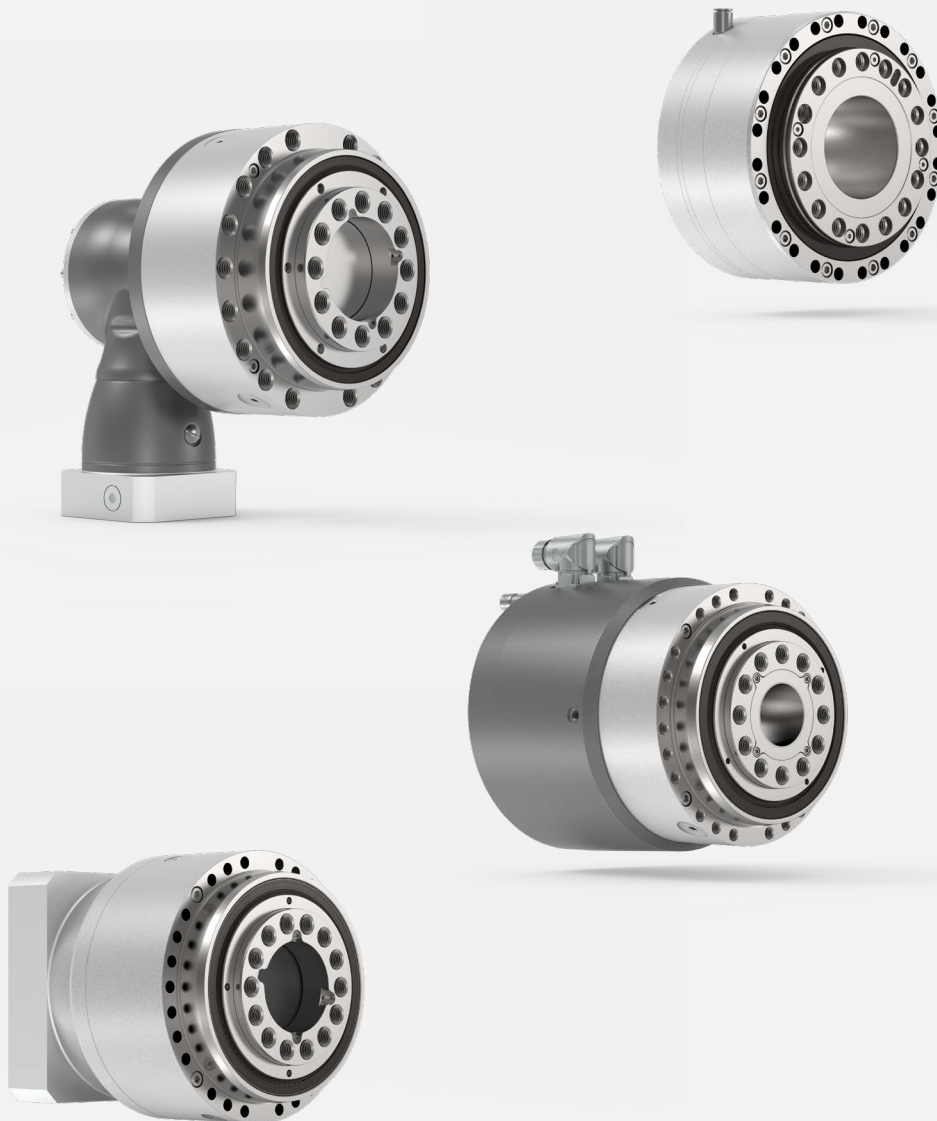

WITTENSTEIN motion control



motion control

WITTENSTEIN motion control uses own servo motors, gearboxes, electronics and software to develop, produce and sell customized mechatronic systems for especially critical environments. Our development expertise and the high level of vertical integration of the components ensure that these technologies meet our customers' requirements.

Our innovative solutions are focused on fields where success depends on performance, robustness and reliability – aerospace, simulation, defense and subsea. Real-time safety software rounds off our portfolio.



attocube systems



attocube develops, produces and sells drive and measurement technology for highly demanding nanotech applications. The product range includes everything from nano drives through fully integrated microscope systems to innovative sensor solutions, which far exceed current measurement technology in their precision, speed and compactness and can also be used under extreme conditions.

Years of experience and expertise in both the scientific and industrial market segments have yielded an inspiring product catalog with maximum precision and user-friendliness. This clearly superior technology is revolutionizing existing applications and guarantees lasting competitive advantages for our customers.



baramundi software

baramundi provides companies and organizations worldwide with efficient, secure and cross-platform management of networked endpoints in IT and manufacturing. The Management Suite provides our customers with integrated, future-orientated unified endpoint management.

baramundi leads the way in regard to unified endpoint management in networked production environments. We develop this solution in close cooperation with the WITTENSTEIN Digitalization Center.



We are there for you:
+49 7931 493-0





Our customer SCHMALZ is systematically expanding its products' connectivity for use in the digital factory. SCHMALZ puts its trust in our innovations for this purpose. An SK gearbox has been extended with a smart WITTENSTEIN module in a complex shuttle and vacuum system for a machine tool. The complete system can now supply sensor data on temperature, acceleration, vibration, negative pressure, energy consumption, etc. to an IIoT Gateway, where it can be collected, interpreted and made retrievable. Users thus have access to information on plant conditions, error diagnostics and predictive maintenance.

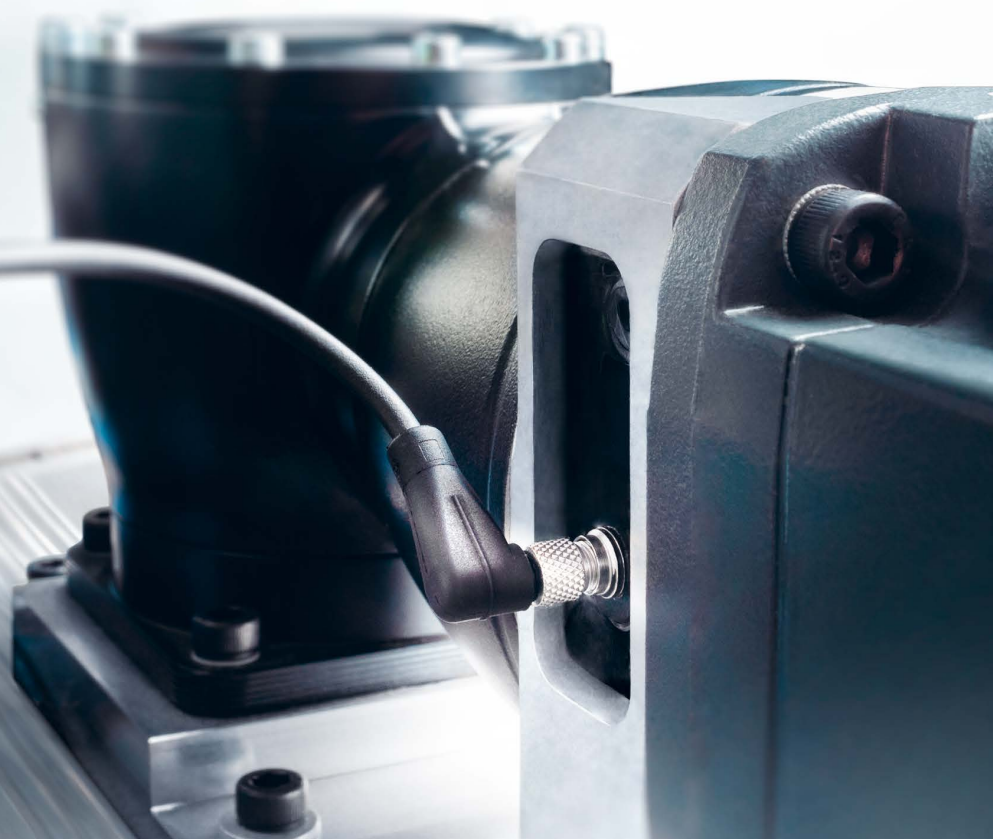

Digitalization

To enable us to drive digitalization forward, we have set up a separate organizational unit – the Digitalization Center. There, we are systematically developing our competencies in the areas of software, sensors, electronics and data. We have defined four strategic focuses, referred to as agile trains:

Smart Factory & Smart Operations addresses an environment in which production machinery and logistics systems have the capability to organize themselves.

Smart Products & Data Driven Services examines how products can collect information both on their environment and on their own status. This serves as a starting point for our customers to improve their production processes in real time and lays the foundation for customized services.

Smart Customer Journey provides, and continuously develops, digital touchpoints in the form of online sizing tools.

Without the Digital Transformation train, all of this would be unthinkable. To enable us to become a digital innovation leader, we endorse an agile culture and seek to acquire sustainable skills. This train also puts the emphasis on maintaining and expanding the partner network as well as on the development of digital business models.

Our Digitalization Center has a vision: in the future, self-learning products and systems will become interconnected through digital awareness. The human beings at the center of the factory control the physical value added by means of virtual replicas of the value chain – from suppliers through customers to our production facilities.

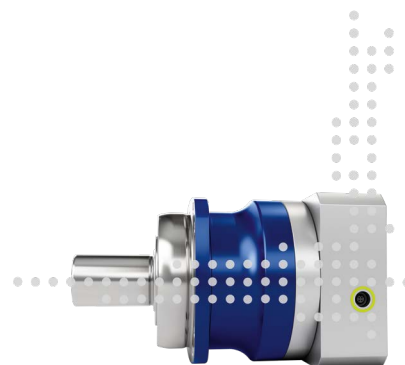

From gearbox to IIoT:
WITTENSTEIN's smart gearbox has an integrated sensor module that enables Industry 4.0 connectivity.

15:47

Daniel Meißner's journey
"on the road" took him
to northern Vietnam.
He found accommodation
there with a family belonging
to the H'mông people,
an ethnic group renowned
for their warm hospitality.





PIONEERS hit the Road

Our “PIONEERS hit the road” initiative offers young vocational training or academic graduates an opportunity for a unique experience abroad before entering professional life. Subject to a few conditions, they propose their own job assignment and organize their stay in a foreign country in order to discover, experience and forge new paths. The number of employees who have so far taken advantage of this chance to go on the road as a “journeyman” or a “journeywoman” has meanwhile reached three figures – with Daniel Meißner among them.

Their time on the road gives our young colleagues space for personal fulfillment. It is a period when they have the privilege of getting to know foreign places and cultures and becoming acquainted with, and understanding, alternative working practices and values. It is hoped that the experience gained will improve the pioneers’ cultural competence and develop their personality. This not only has benefits for our next generation of employees – the lessons learned during their travels are also an invaluable asset for our company’s evolution on the way to becoming a global mechatronics corporation.



Our employees have already traveled to many different countries around the globe.



16:38

Pinning racks used to be extremely time-consuming. Precise holes had to be drilled during the installation procedure and any chips carefully removed. Thanks to our INIRA® pinning invention, that job is now far more straightforward: our mounting kit is comprised of a special pin and sleeve, which reduce the time to pin a rack to just one minute – compared to 45 minutes – on average previously.

17:52

Six bee colonies are currently at home in our World Garden in Harthausen.

In the summer months, they each consist of about 50,000 bees; in winter, that figure drops to just 10,000. Each colony produces between 20 and 30 kilos of honey per year. The huge diversity of the trees and shrubs gives the honey a unique flavor. Our beekeeper regularly inspects the brood-combs, making sure everything is alright.

He uses a smoker to calm the bees with a blend of lavender, spruce needles and beech bark.





World Garden

Our World Garden is the only botanical garden owned by an industrial company in Germany. The “Germany – Land of Ideas” local development initiative was so impressed by it that in 2006, they awarded WITTENSTEIN the distinction of being one of 365 “Ambassadors of Germany”. In the meantime, it is home to more than 600 different trees and shrubs from all countries where the Group has a subsidiary or is represented by an authorized dealer. It symbolizes the way the companies of the WITTENSTEIN Group are growing closer together internationally.

When we drew up the planting plans, we made sure there is always something that catches the eye no matter what the time of year. We consider it very important that our visitors, and of course our employees, have a chance to see the plants at all stages of development. It is our firm conviction that the World Garden has benefits for all of us, whether we make a conscious detour or are simply passing by.



The first tree to be featured in our World Garden was a Japanese ornamental cherry. And that's no coincidence – after all, the idea for the World Garden was inspired by the Japanese custom of taking a young sapling along as a gift on special occasions.



19:43

Alexis Ojeda is WITTENSTEIN North America's first Industry Consortium for Advanced Technical Training (ICATT) trainee. The young people who complete this three-year combined company-and-college program end up with a qualification as an industrial mechanic. We set great store by this concept at our international manufacturing locations. It is based on the German idea of theory and practice closely interwoven in a dual vocational system. The first young industrial mechanics, toolmakers and mechatronics fitters in the U.S. and Romania have already completed their apprenticeships.



Vocational Training

Apprentices and undergraduates can choose between commercial, technical and IT qualifications. However, we don't simply qualify our future employees in their specialist fields; together with them, we also build their individual, social and methodological competencies.

To enable us to realize our own ideas with regard to training, we came up with something rather special: our trainees and students profit from interdisciplinary learning in the WITTENSTEIN talent arena. That way, an industrial mechanic also gains an insight into commercial processes while commercial staff get to grips with technical aspects. Practical training is regularly supplemented with formal instruction. After passing their final exams, and provided their performance is adequate, all trainees and students are offered a full-time job with us. After all, we are constantly searching for qualified specialists.



Our employer campaign was launched to find people with "ideas in motion" who can help get our company ahead.

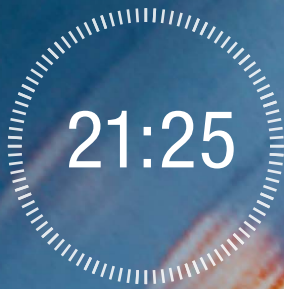

21:25

The Large Hadron Collider at the CERN research facility crossing the Swiss / French border close to Geneva is the largest and most powerful particle accelerator in the world. Here, the nanoprecise IDS3010 displacement sensor (developed and manufactured by our subsidiary attocube) is employed under the most extreme conditions, including intense radiation, ultra high vacuum and high bakeout temperatures. Its tasks include monitoring the accelerator's so-called beam dumps. These dumps must withstand the enormous energy of the LHC particle beams and are critical for the accelerator's operation. Their position both during high intensity impacts and over the long term must therefore be monitored reliably and precisely, to allow preventative maintenance to be performed before costly downtime occurs in the accelerator's operation.

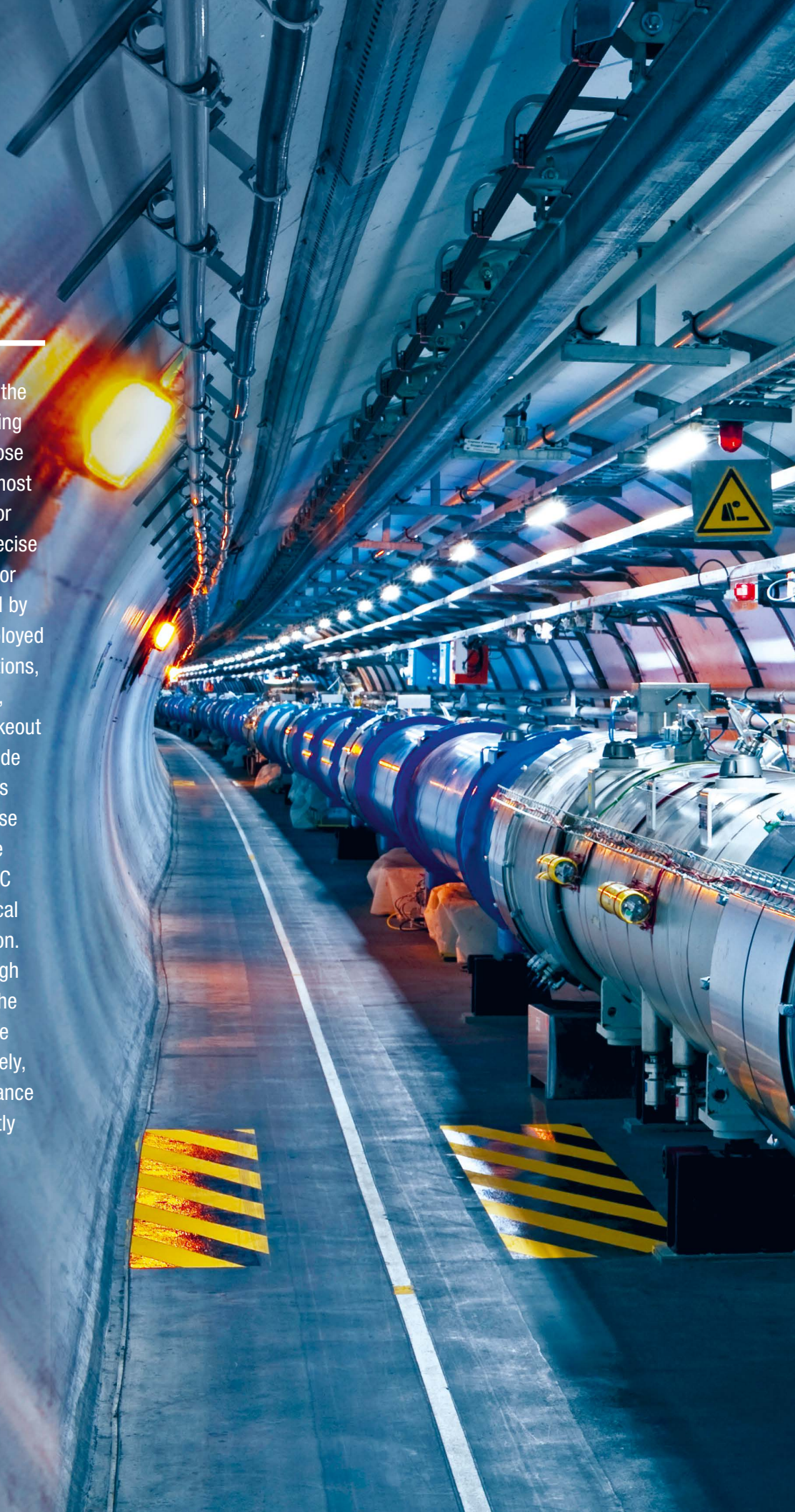

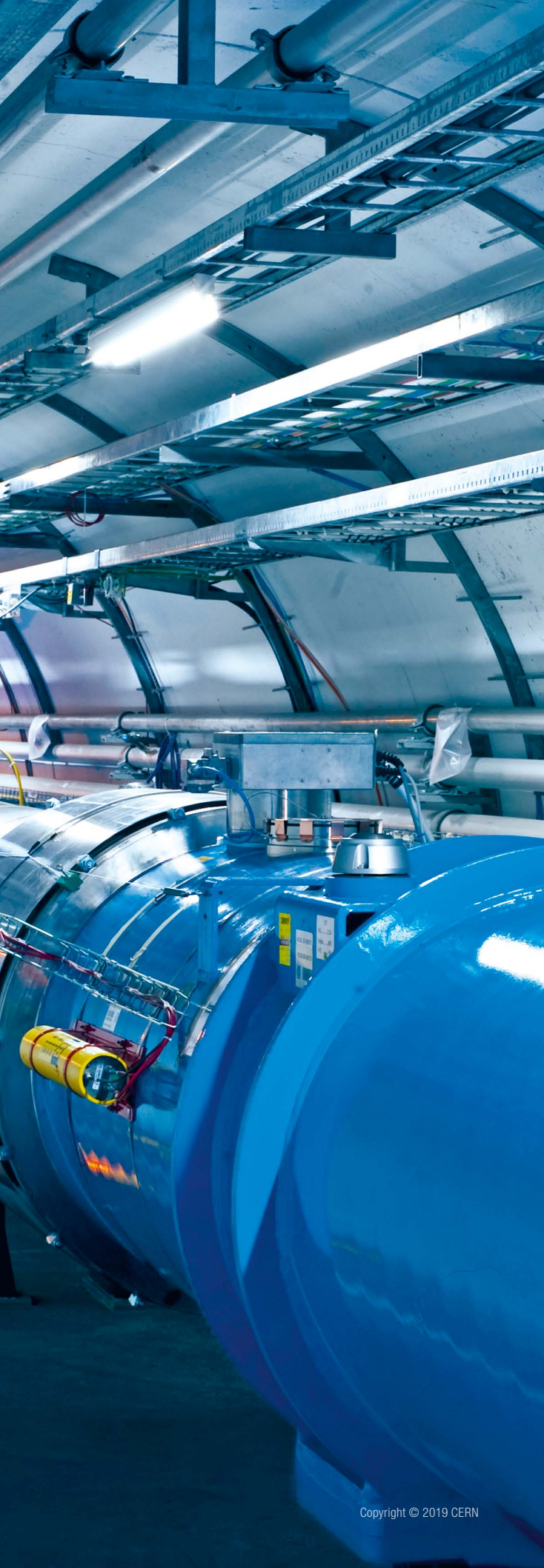

Nanoprecision

As a pioneer in the field of nanotechnology, our attocube systems subsidiary is a solution provider and trailblazer for highly demanding applications in research and industry. The portfolio includes nanopositioners, an ultra precise distance sensor and microscope and cryostat systems that push the limits of what is physically and technically possible. attocube products can operate under extreme conditions such as ultra high vacuum, high magnetic fields, radioactive environments and very high or low temperatures.

This vastly superior technology of the products is revolutionizing existing applications and giving customers valuable competitive advantages. attocube has won several important awards for its products and its innovative company spirit, the most important of which are the Bavarian Innovation Award, the German Startup Award and the TOP 100 Innovation Award.



How big is a nanometer?
If a seagull lands on a cruise ship, the ship is displaced in the water by one nanometer. Neither the human eye nor optical microscopes can detect such dimensions – but attocube's customers can.



We want every one of our employees to get a good night's sleep. That's why we offer an insightful seminar on this topic, where participants can learn how to find rest and relaxation so that they are fit again the next morning and raring to go. For example, to stop yourself from counting sheep at night for hours on end, it's a good idea to remove all electronic gadgets from your bedroom, drink a cup of herbal tea containing valerian and passion flower and minimize emotional distress after the sun goes down.

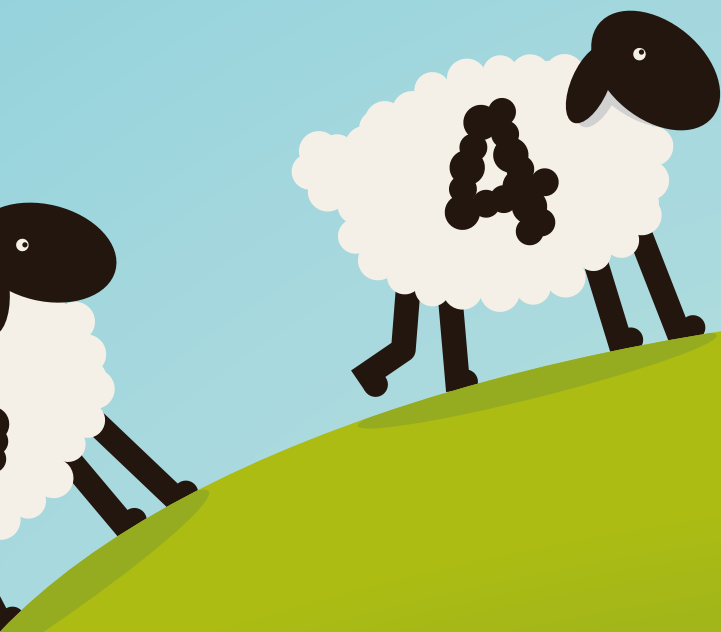

Further Training

Our employees spend 3.5 days a year on average undertaking further training. More than 90% of them sign up for one of our regular seminars. We are proud of this demonstration of their commitment, which gives us a knowledge advantage for the future. The WITTENSTEIN academy was set up with the aim of communicating profound expertise. Every year, we offer more than 2000 learning opportunities, from labor law to techniques for reading drawings – half of them in the form of e-learning modules and virtual classroom training.

All of these further training measures are based on what WITTENSTEIN actually needs and closely coordinated with the relevant departments, to ensure the maximum possible learning success. Our management training is specially designed for the managers of tomorrow. This seminar must be attended by anyone wishing to take responsibility at our company. We have various measures in place to help our employees find a good work-life balance.



The nonprofit Hertie Foundation's "berufundfamilie" (Career and Family) certificate has meanwhile been awarded to us for the fourth time.

24

