

M-Version



TP & TP-High Torque[®]



S-Version

K-Version



TP Low-backlash planetary gear

Operating Manual



1 Contents

1	Contents	2
1.1	Service Contact	2
2	General Information	3
2.1	Description, Designations	3
2.2	Whom does this manual concern?	3
2.3	Which signs and symbols are referred to in this manual?	3
2.4	Exclusion of liability	3
2.5	Modifications, Reconstructions	3
2.6	EC Machinery Directive	3
2.7	Technical Modifications	3
2.8	Copyright	3
3	Safety	3
3.1	Regulation-compliant usage	3
3.2	Usage which is non-compliant with regulations	4
3.3	Group of persons	4
3.4	Symbol Description	4
3.5	Tightening Torques	4
3.6	In case of fire	4
3.6.1	Suitable extinguishing agents	4
3.6.2	Unsuitable extinguishing agents	4
3.6.3	Additional Information	4
4	Technical Specifications	4
4.1	Design	4
4.1.1	Integrated "E" and "EA"	4
4.1.2	Motor-mounted "M" and "MA"	5
4.1.3	Self Contained "S"	5
4.1.4	Angle gear "K"	6
4.2	Weights	6
4.3	Quantity of lubricant and types	6
4.3.1	M Version Lubricant Quantities	7
4.3.2	MA Version Quantities	7
4.3.3	S Version Lubricant Quantities	8
4.3.4	K Version Lubricant Quantities	8
4.4	Performance Statistics	9
4.5	Identification Plate, Ordering Key	9
5	Delivery Status, Transport, Storage	10
5.1	Delivery Status	10
5.2	Transport	10
5.2.1	Transport using hoisting equipment	11
5.3	Storage	11
6	Mounting, Putting into Operation	11
6.1	Preparation	11
6.2	Mounting the motor	13
6.3	Mounting the gear reducer	15
6.3.1	Mountings on the output flange	16
6.3.2	Mounting the gear reducer onto your machine	16
6.4	Putting into Operation	16
7	Operation	16
7.1	Operation conditions	16
8	Maintenance	17
8.1	Shutdown, preparation	17
8.2	Checking Schedule	17
8.3	Maintenance Work	17
8.3.1	Visual Inspection	17
8.3.2	Checking the tightening torques	18
8.3.3	Oil Change	18
8.4	Start-up after maintenance work	19
9	Supplementary Information	19

1.1 Service Contact

Please consult our service department for technical information:

Tel.: +49 7931 493 900

Fax: +49 7931 493 903

E-mail: service@alphagetriebe.de

Address:

alpha getriebebau GmbH

Walter-Wittenstein-Str. 1

D-97999 Igersheim

2 General Information

2.1 Description, Designations

The TP low-backlash planetary gear reducer (henceforth designated gear reducer) is available as an integrated “E”, “M” (motor-mounted), “S” (self-contained), “K” (angle gear) “EA” (integrated TPHigh Torque®) and “MA” (motor-mounted TPHigh Torque®).

2.2 Whom does this manual concern?

This manual concerns all persons who install, operate, or maintain this gear reducer. They may only carry out work on the gear reducer, if they have read and understood this operating manual. Please pass the safety instructions on to other persons as well.

2.3 Which signs and symbols are referred to in this manual?

Ü An “action instruction”, which requires you to carry out an action.

Ñ With a “check” you can specify whether the device is ready for the next work stage.

J A “usage tip” shows you an option of facilitating or improving operations.

The safety instructions symbols are described in the “Safety” section.

2.4 Exclusion of liability

The manufacturer does not accept liability for damage or injury ensuing from improper handling of the gear reducer.

2.5 Modifications, Reconstructions

Modifications or reconstructions of the gear reducer may only be carried out with the express written authorisation of **alpha getriebebau**.

2.6 EC Machinery Directive

Within terms of the EC machinery directive 98/37 EC, the gear reducer is not considered an autonomous machine, but as a component to install in machines.

Operation is prohibited within the area of validity of the EC directive, until it has been determined that the machine, in which this product is installed, corresponds to the regulations within this directive.

2.7 Technical Modifications

alpha getriebebau reserves the right of carrying out technical modifications to improve the product.

2.8 Copyright

© 2001, **alpha getriebebau** GmbH

3 Safety

3.1 Regulation-compliant usage

The gear reducer is designed for industrial applications. Please refer to our catalogue or our Internet page for the maximum permitted torques and speeds:

www.alphagetriebe.de/gear.

Ü Please consult our service department ([see 1.1](#)), if your gear reducer is older than a year. In this way you receive valid data.

3.2 Usage which is non-compliant with regulations

Every usage which exceeds the limits stated above (especially higher torques and speeds) is not compliant with the regulations, and is thus prohibited.

The operation of the gear reducer is prohibited if:

- it was not mounted according to regulations (e.g., securing the motor),
- it was not installed according to regulations (e.g., securing screws),
- the gear reducer is very soiled,
- it is operated without lubricant.

3.3 Group of persons

The gear reducer may only be installed, maintained, and dismantled by trained technicians.

3.4 Symbol Description

The following symbols are used in this operating manual to warn you of hazards:



DANGER!

This symbol warns you of danger of injury to yourself and others.



Attention

This symbol warns you of the risk of damage to the gear reducer.



Environment

This symbol warns of environmental pollution risk.

3.5 Tightening Torques

All screwed connections for which a tightening torque is specified, must on principle be tightened with a calibrated torque wrench, and checked.

3.6 In case of fire

The gear reducer itself is inflammable. However, it usually contains a synthetic gear oil (polyglycol).

Ü Please observe the following instructions, if the gear reducer is situated in a burning environment.

3.6.1 Suitable extinguishing agents

Carbon dioxide, powder, foam, fog

3.6.2 Unsuitable extinguishing agents

Do not spray with water!

3.6.3 Additional Information



Environment

Ü Prevent the penetration of the lubricant in drains, sewers, and water resources.

For additional information on RENOLIN PG 220 gear reducer oil, refer to:

FUCHS MINERALOELWERKE GmbH, Mannheim Tel.: +49 (0) 621 / 3701-333

4 Technical Specifications

4.1 Design

4.1.1 Integrated “E” and “EA”

(See [fig 4.1](#) for diagram) The output bearing is designed to receive high external tilting moments and axial forces.

The large ISO 9409 output flange has two centring mechanisms and a bore hole for an indexing pin so that the gear reducer (or the application) can be zeroed mechanically.

Exception: TP300, TP500 and TPHigh Torque (EA).

4.1.2 Motor-mounted “M” and “MA”

The motor-mounted gear reducer “M” is based on the integrated “E” and extra mounting parts (see [fig. 4.1](#)). The TPHigh Torque® “MA” is based on the integrated “EA” (no diagram).

The clamping hub enables a quick and easy mounting of the motor.

The centring of the motor in relation to the gear reducer axis is done through the clamping hub, which is supported in bearings. Centring the adapter plate is then not necessary; it only involves a recess. The motor can thus be mounted without distortion caused by manufacture inaccuracies.

High flexibility is assured by being able to adapt the reducer to various motors through the functions of adapter plate and the spacer sleeve.

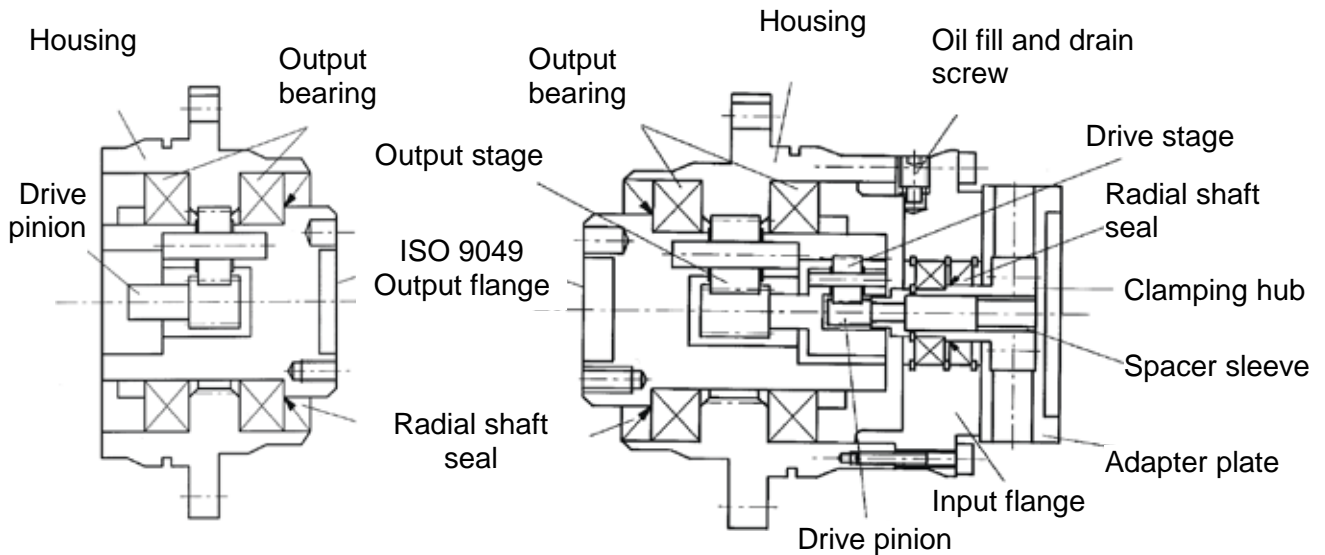

Fig. 4.1 shows the single stage version “E” and the two stage version “M”

4.1.3 Self Contained “S”

The self contained version “S” is based on the TP integrated “E” and extra mounting parts, such as input flange and drive shaft.

The drive shaft gives the option of driving the gear reducer directly, for instance, via a belt pulley.

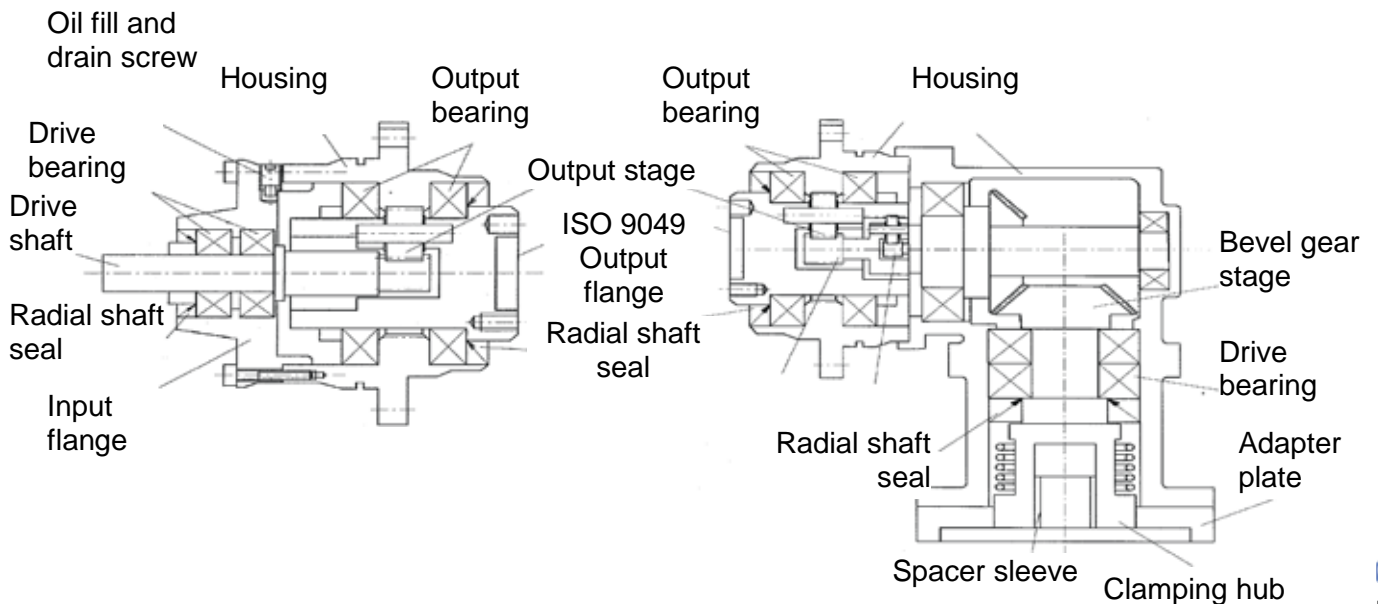

Fig. 4.2 shows the single stage version “S” and the three stage version “K”

4.1.4 **Angle gear “K”**

The angle gear “K” is based on the TP integrated “E” and an additionally mounted bevel gear stage.

The clamping hub enables a quick and easy mounting of the motor.

The centring of the motor in relation to the gear reducer axis is done through the clamping hub, which is supported in bearings. Centring the adapter plate is then not necessary; it only involves a recess. The motor can thus be mounted without distortion caused by manufacture inaccuracies.

High flexibility is assured by being able to adapt the reducer to various motors through the functions of adapter plate and the spacer sleeve. The right-angled alignment of the gear reducer offers a space-saving option for mounting the motor.

4.2 **Weights**

The weight of the gear reducer ranges from 1.2 to 85 kg.

J The tables in [chapter 5.2](#) help you in a more exact specification of the sizes.

4.3 **Quantity of lubricant and types**

The integrated “E” gear reducer is open, and thus is not filled with lubricant at delivery. The “M”, “MA”, “S” and “K” versions are filled with synthetic gear oil by the manufacturer; viscosity class ISO VG 220 (Fuchs, Renolin PG 220). Renolin PG 68, PG 100 or Optimol PD1 grease, for example, are also used in special cases.

The following tables specify all permitted oils of the viscosity class ISO VG 220. You can find additional information from the manufacturer at the specified Internet addresses.

Manu-facturer	Lubricant	Internet address
Aral	Degol GS 220	www.aral.de
BP	Energol SG-XP 220	www.bp.com
DEA	Polydea CLP 220	www.dea.de
Fuchs	Renolin PG 220	www.fuchs-oil.de
Klüber	Klübersynth GH 6-220	www.klueber.com
	Syntheso HT 220/ Syntheso D 220 EP	-
Mobil	Glygoyle 30 / Glygoyle HE220	www.mobil.com
Molyduval	Syntholube G 220 EP	www.molyduval.com
Optimol	Optiflex 220	www.optimol.com
Shell	Tivela Oil WB (PG 220)	www.shell.com
OPTIGEAR SYNTHETIC (formerly TRIBOL)	800/220	www.castrol-industrie.com/

Table 4.1

The filled lubricant and the required lubricant quantities are specified on the identification plate. These apply for a typical positioning operating mode, and for the mounting position stated with the order. If the mounting position is not known on ordering, the lubricant quantity is filled for the horizontal mounting position.

Ü Correct the lubricant quantity, if required, according to the following tables.



Attention

Mixing different lubricants can impair the lubricant properties. It can destroy the gear reducer.

Ü Only re-fill with the lubricant type that is in the gear reducer.

Ü If you wish to use another lubricant, carry out a complete oil change (with flushing).

The ambient temperature may not be under -10°C and not over $+40^{\circ}\text{C}$. Operating temperature may not exceed $+90^{\circ}\text{C}$.

Divergent operating conditions may make different lubricant quantities and different lubricants necessary.

Ü In these cases, please consult **alpha getriebebau**.

You can find the lubricant quantities for your gear reducer in the following sections. Please note the integrated version (e.g. M, MA, S, or K), the mounting position (e.g. B5), and the stage number of the gear unit.

4.3.1

M Version Lubricant Quantities

M Version		Lubricant quantities [cm ³]													
Type		TP 004		TP 010		TP 025		TP 050		TP 110		TP 300		TP 500	
Stages		1	2	1	2	1	2	1	2	1	2	1	2	1	2
	B5 horizontal	10	18	25	35	50	70	125	110	300	320	800	700	1200	1250
	V3 vertical, output flange facing upwards	15	18	45	35	70	70	170	200	500	500	1300	1000	2000	1500
	V1 vertical, output flange facing downwards	10	18	25	35	50	70	125	200	300	500	800	1000	1200	1500
	S can swivel ±90° from horizontal position	15	18	45	35	70	70	170	200	500	500	1300	1000	2000	1500

Table 4.2

4.3.2

MA Version Quantities

MA Version		Lubricant quantities [cm ³]											
Type		TP 010		TP 025		TP 050		TP 110		TP 300		TP 500	
Stages		2	3	2	3	2	3	2	3	2	3	2	3
	B5 horizontal	55	55	110	110	250	200	600	600	1000	1000	1500	1500
	V3 vertical, output flange facing upwards	90	90	170	140	400	330	900	900	2200	2200	2900	2900
	V1 vertical, output flange facing downwards	90	90	140	140	400	330	900	900	2200	2200	2900	2900
	S can swivel ±90° from horizontal position	90	90	170	140	400	330	900	900	2200	2200	2900	2900

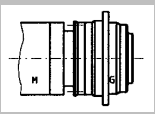
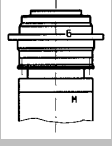
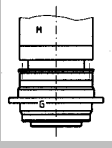
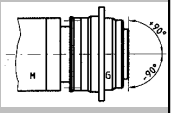
Table 4.3

4.3.3 **S Version Lubricant Quantities**

on demand

4.3.4 **K Version Lubricant Quantities**

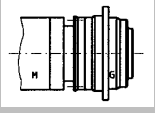
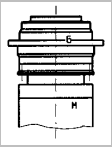
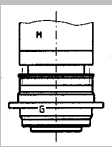
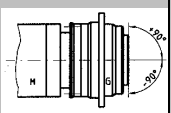
K Version		Lubricant quantities [cm ³]									
Type		TP 010		TP 025		TP 050		TP 110		TP 300	
Stages		2	3	2	3	2	3	2	3	2	3
	B5/V3 Output flange horizontal, motor shaft facing upwards	130	75	220	90	450	180	1500	470	-	1200
	B5/V1 Output flange horizontal, motor shaft facing downwards	130	75	220	90	450	180	1500	470	-	1200
	V1/B5 Output flange vertical facing downwards, motor shaft horizontal	130	120	220	140	700	290	1500	750	-	1450
	V3/B5 Output flange vertical facing upwards, motor shaft horizontal	210	120	390	140	700	290	2300	750	-	1450
	B5/B5 Output flange horizontal, motor shaft horizontal	130	75	220	90	450	180	1500	470	-	1200
	S can swivel 360°	210		390	140	700	290	2300	750	-	1450

Table 4.5

4.4 Performance Statistics

Please refer to our catalogue or our Internet page for the maximum permitted torques and speeds: <http://www.alphagetriebe.de/gear>.

Ü Please consult our service department ([see 1.1](#)), if your gear reducer is older than a year. In this way you receive valid data.

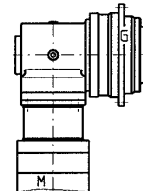
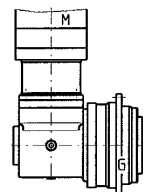
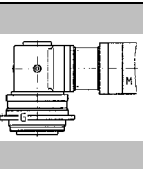
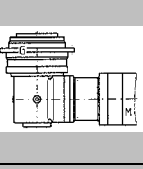
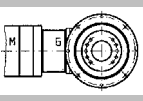
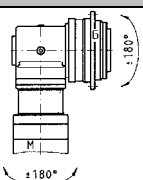
4.5 Identification Plate, Ordering Key

In the "M", "MA", "S", and "K" version, the identification plate (A) is located on the input flange.

In the "E" version, the identification plate (B) is located in the output flange.

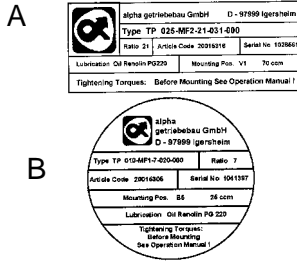

Fig. 4.3

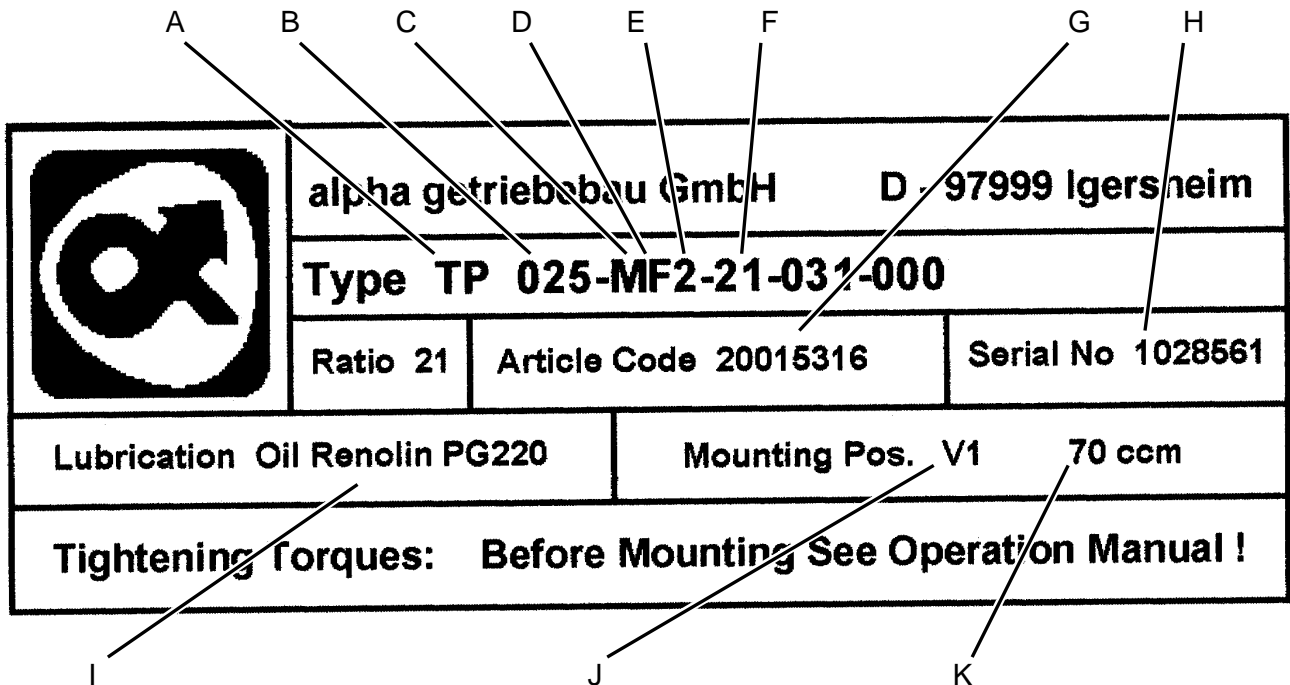

Fig. 4.4

The identification plate informs you of the following specifications:

- | | | | |
|---|--------------------------------|---|--|
| A | Type of gear reducer (e.g.:TP) | G | Article code (e.g.: 20015316) |
| B | Size (e.g.: 025) | H | Serial number (e.g.: 1028561) |
| C | Version (e.g.: M) | I | Lubricant (e.g.: Renolin PG220) |
| D | Design (e.g. F = Standard) | J | Mounting position (e.g.: V1) |
| E | Stage number (e.g.: 2) | K | Lubricant quantity for the designated mounting position (e.g.: 70 ccm) |
| F | Ratio (e.g.: 21) | | |

TP 025 - MF2 - 21- 031/Motor - V1

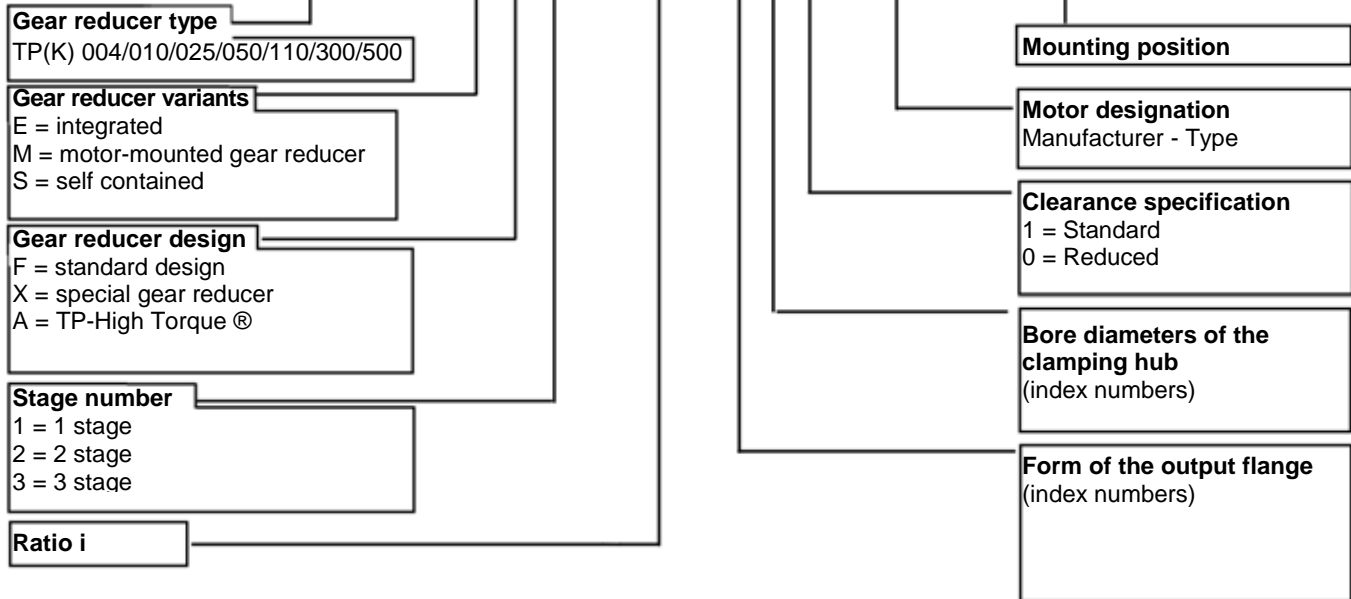

Fig. 4.5: Ordering Key

5 Delivery Status, Transport, Storage

5.1 Delivery Status

Within Europe, the gear reducers are packed in cardboard boxes with paper padding. The paper padding is re-usable and can be recycled.

To ship overseas, the gear reducers are wrapped in foil (PE) and foamed into the cardboard box (diphenylmethane). Please dispose of packing material according to the valid national regulations.

The “E” gear reducer is provided with an anti-corrosion agent at the output. The “M”, “MA”, “S”, and “K” versions are provided with an anti-corrosion agent at the input and output.

The integrated “E” gear reducer is open, and thus is not filled with lubricant at delivery. The “M”, “MA”, “S”, and “K” versions are filled with synthetic gear oil by the manufacturer.

5.2 Transport

No special direction or position is prescribed to transport the gear reducer.

The weight of the gear reducer ranges from 1.2 to 85 kg.

The following tables are designed to help you specify the sizes of your gear reducer.

Weight [kg]						
Design	M		MA	S	K	
Stages	1	2	2 / 3	1 / 2	2	3
TP 004	1.2	1.3	-	-	-	-
TP 010	2.6	2.8	3.8	3.2	7.0	4.9
TP 025	4.6	4.7	6.2	5.2	11.5	7.0
TP 050	9.6	9.7	13.4	10.3	23	13.8
TP 110	24	24.1	35	25.4	48	29.3
TP 300	-	55	-	-	-	65
TP 500	-	85	-	-	-	-

Table 5.1

5.2.1 **Transport using hoisting equipment**



DANGER!

Falling loads or breakage of fastening equipment can cause injury.

Ü Do not stand under suspended loads.

Ü Keep as safe a distance as possible from securing equipment.



Attention

Falling or hard placement can damage the gear reducer.

Ü Only use hoisting and securing equipment which is permitted for the size / weight of your gear reducer.

Ü Take heed that the load is slowly and carefully handled and placed.

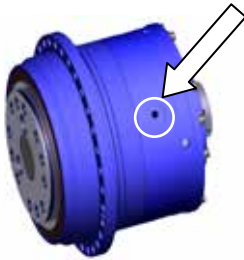

Gear reducers from the TP 300 size upwards have support bores for ring screws (e.g. according to DIN 580) in the gear unit housing.

Fig. 5.1

5.3 **Storage**

The gear reducer can be stored dry and in a horizontal position in the original packing for a maximum of 2 years at a temperature between 0°C and +30°C. As storage logistic, we recommend the “first in - first out” principle.

6 **Mounting, Putting into Operation**



DANGER!

Inappropriately executed work can lead to injury and damage.

Ü Make sure that the gear reducer is only installed, maintained, and dismantled by trained technicians.

6.1 **Preparation**

The “E” gear reducer is provided with an anti-corrosion agent at the output. The “M”, “MA”, “S”, and “K” versions are provided with an anti-corrosion agent at the input and output.

Ü Remove all traces of the anti-corrosion agent in all versions before mounting the gear reducer.



Attention

Pressurised air can damage the gear reducer seals, and thus lead to leakage.

Ü Do not blow out the flanges with pressurised air when cleaning.

The sealing of the input and output with radial shaft seals makes the “M”, “MA”, “K”, and “S” gear reducers completely closed to the outside.

The integrated “E” is open at the input, i.e., no radial shaft seal is provided. The gear reducer can, however, be sealed to the outside with an O-ring (fig. 6.1).

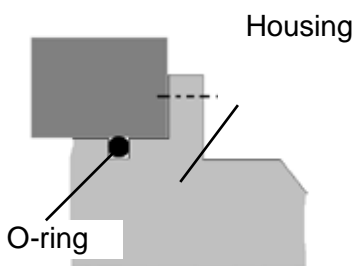

Fig. 6.1

Gear reducer size	O-ring
TP 004	66 x 2
TP 010	90 x 3
TP 025	114 x 3
TP 050	145 x 3
TP 110	200 x 5
TP 300	238 x 5
TP 500	270 x 6

Table 6.1

Please refer to tables 6.2 and 6.3 to find out the gear reducer's thread and bore diameters. An extra indexing bore hole is sited in the output flange, in order to obtain exact positioning.

Thread in output flange											
Gear reducer size	Design						Quantity x thread	Indexing bore hole Ø	Property class	Tightening torque	
	M	MA	S	K	E	EA				[Nm]	
TP 004	X				X		7 x M 5	5 H 7	10.9	8.1	
TP 010	X		X	X	X		7 x M 6	6 H 7	10.9	14	
TP 010		X				X	12 x M 6	-	10.9	14	
TP 025	X		X	X	X		11 x M 6	6 H 7	10.9	14	
TP 025		X				X	12 x M 8	-	10.9	34	
TP 050	X		X	X	X		11 x M 8	8 H 7	10.9	34	
TP 050		X				X	12 x M10	-	10.9	67	
TP 110	X		X	X	X		11 x M10	10 H 7	10.9	67	
TP 110		X				X	12 x M12	-	10.9	115	
TP 300	X			X	X		12 x M16	-	10.9	290	
TP 300		X				X	12 x M20	-	10.9	560	
TP 500	X				X		12 x M20	-	10.9	560	
TP 500		X				X	12 x M24	-	10.9	950	

Table 6.2

Through-holes in gear unit housing									
Gear reducer size	Design					Quantity x diameter	For property class	Tightening torque	
	M	MA	S	K	E			[Nm]	
TP 004	X				X	8 x 4.5	M4 10.9	4.1	
TP 010	X		X	X	X	8 x 5.5	M5 10.9	8.1	
TP 010		X				16 x 5.5	M5 10.9	8.1	
TP 025	X		X	X	X	8 x 5.5	M5 10.9	8.1	
TP 025		X				16 x 5.5	M5 10.9	8.1	
TP 050	X		X	X	X	12 x 6.6	M6 10.9	14.0	
TP 050		X				24 x 6.6	M6 10.9	14.0	
TP 110	X		X	X	X	12 x 9.0	M8 10.9	34.0	
TP 110		X				24 x 9.0	M8 10.9	34.0	
TP 300	X			X	X	16 x 13.5	M12 10.9	115.0	
TP 300		X				32 x 13.5	M12 10.9	115.0	
TP 500	X				X	16 x 13.5	M12 10.9	115.0	
TP 500		X				32 x 13.5	M12 10.9	115.0	

Table 6.3

6.2 Mounting the motor

The “M”, “MA” and “K” gear reducers are designed for motor-mounting. The motors to be mounted must:

- correspond to the B5 design,
- show a radial and axial runout tolerance of “N” according to DIN 42955, and,
- if possible, have a smooth shaft.



Attention

Distortion can damage the motor and the gear reducer.

Ü Take heed the motor is mounted in a vertical position.

Ü If the motor shaft has a feather key, remove the feather key.

A clamping hub connects the motor shaft and the gear drive shaft. A slotted spacer sleeve is used extra for certain motor shaft diameters and applications (see fig. 6.2).

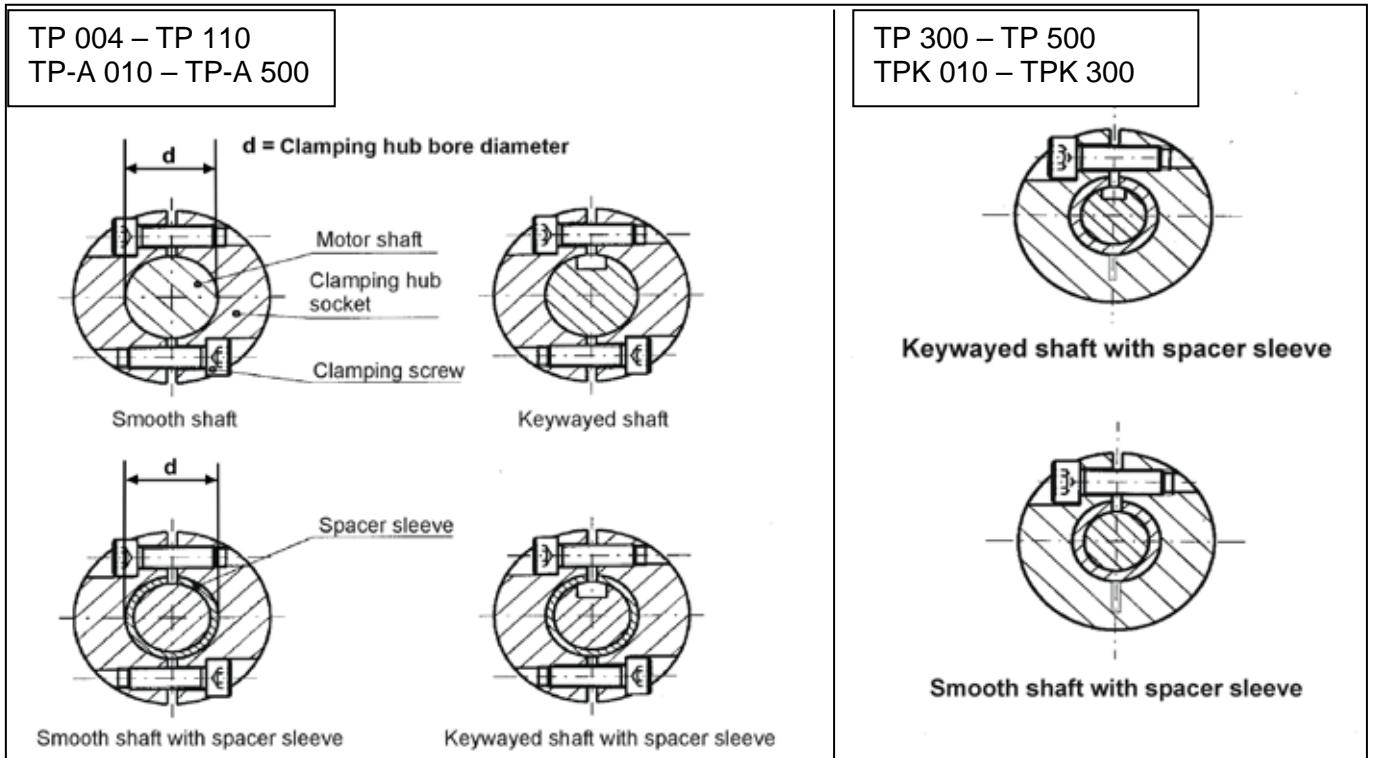

Fig. 6.2

Ü Clean the plane surfaces of the motor and gear reducer.

Ü Clean the motor shaft, the clamping hub bore hole, and, if required, the spacer sleeve.

Ñ Take care that the slot of the spacer sleeve is positioned coincident to the slot of the clamping hub.

Ü Turn the clamping hub so that the clamping screws are positioned coincident to the mounting holes in the adapter plate.



Attention

Excessively high axial forces can damage the motor and gear reducer.

Ü Take care that occurring axial forces are no higher than specified in tables 6.4 to 6.6.

Specifications for the “M” version

Size	Stages	Clamping hub interior Æ [mm]	Clamping screw DIN 912-12.9	Width across flats [mm]	Tightening torque [Nm]	max. axial force [N]
TP 004	1	£ 14	M 4	3	5,0	80
	2	£ 11	M 4	3	5,0	55
TP 010	1	£ 19	M 5	4	9,5	100
	2	£ 11	M 4	3	5,0	55
		11 £ 14	M 4	3	5,0	80
TP 025	1	£ 14	M 5	4	9,5	100
		14 £ 19	M 6	5	16,0	100
		19 £ 32	M 8	6	39,0	100
	2	£ 14	M 4	3	5,0	80
		14 £ 19	M 5	4	9,5	100
TP 050	1	£ 19	M 6	5	16,0	150
		19 £ 24	M 8	6	39,0	150
		24 £ 38	M 10	8	77,0	150
	2	£ 19	M 6	4	9,5	100
		19 £ 32	M 8	6	39,0	100
TP 110	1	32 £ 48	M10	8	77,0	190
	2	£ 14	M 5	4	9,5	100
		14 £ 19	M 6	5	16,0	100
		19 £ 24	M 8	6	39,0	100
		24 £ 38	M10	8	77,0	150
TP 300	2	£ 35	M10	8	65,0 * ¹⁾	80
TP 500	2	£ 48	M12	10	115,0 * ¹⁾	118

Table 6.4

*¹⁾ = reduced

Specifications for the “MA” version

Size	Stages	Clamping hub interior Æ [mm] ¹⁾	Clamping screw DIN 912-12.9	Width across flats [mm]	Tightening torque [Nm]	max. axial force [N]
TP 010	2/3	£ 14	M 4	3	5.0	80
	2/3	£ 24	M 8	6	39.0	100
TP 025	2/3	£ 19	M 5	4	9.5	100
	2/3	£ 35	M 10	8	77.0	150
TP 050	2/3	£ 32	M 8	6	39.0	100
	2/3	£ 38	M 10	8	77.0	150
TP 110	2/3	£ 38	M 10	8	77.0	150
	2/3	£ 48	M 10	8	77.0	190
TP 300	2/3	£ 38	M 10	8	77.0	150
TP 500	2/3	£ 48	M 10	8	77.0	190

Table 6.5

Specifications for the “K” version

Size	Stages	Clamping hub interior \varnothing [mm] ¹⁾	Clamping screw DIN 912 12.9	Width across flats [mm]	Tightening torque [Nm]	max. axial force [N]
TPK 010	2	£ 19	M 6	5	14.0	51
	3	£ 14	M 5	4	8.0	17
TPK 025	2	£ 28	M 8	6	30.0	49
	3	£ 14	M 5	4	8.0	17
TPK 050	2	£ 35	M10	8	65.0	80
	3	£ 19	M 6	5	14.0	51
TPK 110	2	£ 48	M12	10	115.0	118
	3	£ 28	M 8	6	30.0	49
TPK 300	3	£ 35	M 10	8	65.0	80

Table 6.6



Attention

Motors with

- shaft shoulder,
- distinctive chamfer radius, or
- longer shafts than are permitted for the relevant gear reducer

lead to distortions in mounting, which damage the motor and the gear reducer.

- Ü Check the interfering edges by measuring, or by a measurement check based on our catalogue specifications, and the information of the motor manufacturer.
- Ü Please consult our service department, in order to obtain a wider adapter plate, or an intermediary flange.



- Ü Position the motor so that the adapter plate and the motor fit together.
- Ñ Take heed that the motor allows itself to be moved into position “easily”.
- Ñ There is to be no gap between the motor and the gear reducer.
- Ü Insert the screws in the clamping hub without tightening to the required torque.
- Ü Coat the screws with a screw-bonding agent (e.g. Loctite 243), and screw the motor and the adapter plate together.

- Ü For clamping hubs with two screws, tighten the screws alternately in at least three stages (15% - 50% - 100%) until the tightening torque ([table 6.4](#) to [6.6](#)) is reached.

Fig 6.3

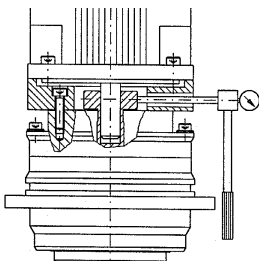

- Ü For clamping hubs with one screw, tighten the screw until the tightening torque has been reached ([table 6.4](#) to [6.6](#)).
- Ü Press the stopper plugs enclosed with the delivery into the mounting bores of the adapter plate until they are flush with the surface.

Fig. 6.4

6.3 Mounting the gear reducer

- Ü Thoroughly clean the output flange, centring, and fitting surface.

6.3.1 **Mountings on the output flange**



Attention

- Distortions during mounting operations can damage the gear reducer.
- Ü Mount gearwheels and toothed belt pulleys onto the output flange without forcing.
- Ü Do not on any account attempt an assembly by force or hammering.
- Ü Only use suitable tools and equipment.
- J You can find the prescribed tightening torques in [table 6.2](#).

6.3.2 **Mounting the gear reducer onto your machine**

Check the lubricant quantity

The gear reducers are compliant for every mounting position; the lubricant quantity, however, is dependent on the mounting position. The filled lubricant and the required lubricant quantities are specified on the identification plate. These apply for the mounting position stated with the order. If the mounting position is not known on ordering, the lubricant quantity is filled for the horizontal mounting position.

- Ü Correct the lubricant quantity, if required, according to the tables in [chapter 4.3](#).



Attention

- Mixing different lubricants can impair the lubricant properties. It can destroy the gear reducer.
- Ü Only re-fill with the lubricant type that is in the gear reducer.
- Ü If you wish to use another lubricant, carry out a complete oil change (with flushing).

Mounting the gear reducer

- J Mount the gear reducer in such a way that the identification plate remains legible.
- Ü Coat the screws with screw-bonding agent (e.g. Loctite 243), and screw the gear unit housing and your machine together.
- J You can find the prescribed screw sizes and tightening torques in [table 6.3](#).

6.4 **Putting into Operation**



DANGER!

- Foreign bodies spinning through the air can cause grave injury.
- Ü Before putting the gear reducer into operation, check that there are no foreign bodies or tools near the gear reducer.

7 **Operation**

7.1 **Operation conditions**

The gear reducer must be installed in a clean and dry environment. Course dust and liquids of all kinds impair its function.

The filled lubricant and the required lubricant quantities are specified on the identification plate. These apply for the mounting position stated with the order. If the mounting position is not known on ordering, the lubricant quantity is filled for the horizontal mounting position. The ambient temperature may not be under -10°C and not over $+40^{\circ}\text{C}$. Operating temperature may not exceed $+90^{\circ}\text{C}$.

Divergent operating conditions may make different lubricant quantities and different lubricants necessary.

- Ü In these cases, please consult **alpha getriebebau**.



DANGER!

- Touching hot surfaces can lead to burns.
- Ü Do not touch the gear reducers if their operating temperatures are too high, or use suitable safety equipment (e.g. gloves).



DANGER!

- Rotating machinery can lead to injury. There is danger of being trapped or pulled in!
- Ü Keep a sufficient distance to rotating machinery.

8 Maintenance



DANGER!

Inappropriately executed work can lead to injury and damage.

Ü Make sure that the gear reducer is only installed, maintained, and dismantled by trained technicians.

8.1 Shutdown, preparation

Ü Shut down the machine in which the gear reducer is installed.

Ü Disconnect the machine from the mains, before starting maintenance work.



DANGER!

An unintentional start of the machine during maintenance work can lead to serious accidents.

Ü Make sure no one can start the machine whilst you are working on it.

Oil change and flushing of the gear reducer do not comprise standard maintenance work.

The machine has to be running to perform both these tasks.



DANGER!

Even a short-period running of the machine during maintenance work can lead to accidents, if the safety devices are not operating.

Ü Make sure that all safety devices are mounted and active.

8.2 Checking Schedule

Maintenance work / See section...	Maintenance periods		
	At start-up	After 500 operating hours or 3 months	Yearly
Visual inspection / 8.3.1	X	X	X
Checking the tightening torques / 8.3.2	X	X	X
Oil change / 8.3.3	Recommended: every 10,000 operating hours Exception: No oil change for the gear reducer size 004		

Table 8.1

8.3 Maintenance Work

8.3.1 Visual Inspection

Ü Check the entire gear reducer by carrying out a thorough visual inspection for exterior damage

Ü The radial shaft seals are wear parts. Thus check the gear reducer also for oil leakage at every visual inspection.

J For general information about radial shaft seals please contact our associate partner www.simrit.de.

J If you have any questions about maintenance please consult our service department (see [1.1](#)).

8.3.2 **Checking the tightening torques**

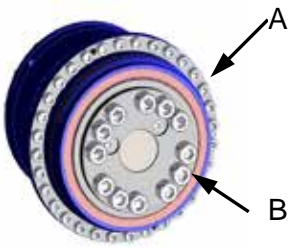

- Ü Check the tightening torques of the securing screws on the gear unit housing (A) and on the output flange (B).
- J You can find the prescribed tightening torques in [table 6.2](#) and [6.3](#) in section 6.
- Ü Check the tightening torque of the clamping bolts on the motor mounting.

Fig. 8.1

8.3.3 **Oil Change**



DANGER!

Extended, intensive contact with synthetic oils can lead to skin irritations.

- Ü Avoid extended contact with oil, and clean oil off skin thoroughly.



Attention

Mixing different lubricants can impair the lubricant properties. It can destroy the gear reducer.

- Ü Only re-fill with the lubricant type that is in the gear reducer.
- Ü If you wish to use another lubricant, carry out a complete oil change (with flushing).

You can find a list of permitted lubricants in [chapter 4.3](#).



Environment

Lubricants (oils and greases) are hazardous substances, which can contaminate soil and water.

- Ü Collect drained lubricant into suitable receptacles and dispose of it according to the valid national guidelines.

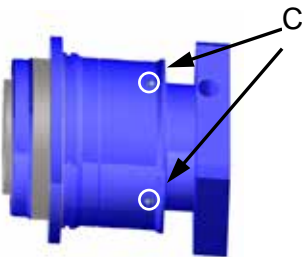

Fig. 8.2

All gear reducers are lubricated for all their working lives. However, we **recommend** an oil change approximately every 10,000 operating hours for synthetic oils as well, since oil becomes contaminated, and thus causes increased wear and tear.
The “E” gear reducers and the “004” size do not have plugs.
All other gear reducers have plugs (C) in the drive housing.

- Ü Heat up the gear reducer to operating temperature.
- Ü Drain the oil off through a plug located below.
- Ü Open a plug situated at top, so that the gear reducer is ventilated.
- J There is still residual oil and dirt in the gear reducer. We recommend that these be flushed out:
 - Screw in the bottom plug, fill with oil, and screw in the top plug.



DANGER!

Even a short-period running of the machine during maintenance work can lead to accidents, if the safety devices are not operating.

- Ü Make sure that all safety devices are mounted and active.
 - Let the machine run for a short time, and drain the oil off again.
- Ü De-grease the bottom plug and coat this with a bonding agent (e.g. Loctite 573).
- Ü Screw the bottom plug tight with the prescribed tightening torque.
- J Refer to [table 8.2](#) for the tightening torque.
- Ü Fill with the prescribed quantity of oil.
- J You can find the prescribed lubricant quantity in [chapter 4.3](#).
- Ü De-grease the plug, and coat this with a bonding agent (e.g. Loctite 573).

- Ü Screw the top plug tight with the prescribed tightening torque.
- J Refer to [table 8.2](#) for the tightening torque.

Gear reducer size	Version	Stages	Plug in drive housing: Quantity x thread x lead	Tightening torque [Nm]
TP 004	M	-	-	-
TP 010	M	1 / 2	3xM8x1	5
	MA	2 / 3	3xM8x1	5
	K	2 / 3	3xM8x1	5
TP 025	M / S	1 / 2	3xM8x1	5
	MA	2 / 3	3xM8x1	5
	K	3	3xM8x1	5
	K	2	3xM12x1.5	10
TP 050	M / S	1 / 2	3xM8x1	5
	MA	2 / 3	3xM8x1	5
	K	3	3xM8x1	5
	K	2	3xM12x1.5	10
TP 110	M / S / K	1 / 2 / 3	3xM12x1.5	10
	MA	2 / 3	3xM8x1	5
TP 300	M (K)	2 (3)	4xM12x1.5	10
	MA	2 / 3	4xM10x1	6
TP 500	M	2	3xM14x1.5	12
	MA	2 / 3	4xM14x1.5	12

Table 8.2

8.4 Start-up after maintenance work

- Ü Clean the outside of the gear reducer.
- Ü Assemble all safety devices.
- Ü Do a test run, before re-releasing the machine for operation.

9 Supplementary Information

- J If you should need supplementary information (e.g. disassembly, or disposal), please contact our service department ([chapter 1.1](#))



WITTENSTEIN alpha GmbH · Walter-Wittenstein-Straße 1 · 97999 Igersheim · Germany
Tel. +49 7931 493-12900 · info@wittenstein.de

WITTENSTEIN - one with the future

www.wittenstein-alpha.de